



Ultra Compact IQ Modulator Bias Controller



Introduction

An IQ modulator consists of three different modulators: I, Q arms are intensity modulators, P arm is a phase modulator. The IQ modulator is typically applied to coherent transmission systems. Rofea's modulator bias controller is specially designed for IQ modulators to ensure a stable operation state in various operating environments. Based on its fully digitized signal processing method, the controller can provide ultra stable performance.

The controller injects a low frequency, low amplitude dither signal together with a bias voltage into the modulator. It keeps reading the output from the modulator and determines the condition of the bias voltage and the related error. A compensate bias voltage will be applied afterwards according to the previous measurements. In this way, the IQ modulator is ensured to work under a proper bias voltage.

The controller is very compact in volume, and is suitable for modern communication systems.

Feature

- Provides three biases for IQ modulators Modulation format independent:
 - QPSK, QAM, OFDM, SSB verified
- Plug and Play:
 - No manual calibration needed Everything automatic
- I, Q arms: controll on Peak and Null modes High extinction ratio: 50dB max¹
- P arm: controll on Q+ and Q- modes Accuracy: $\pm 2^\circ$
- Low profile: 40mm(W) \times 28mm(D) \times 8mm(H)
- High stability: fully digital implementation Easy to use:
 - Manual operation with mini jumper Flexible OEM operations through UART²
- Two modes to provide bias voltages: a. Automatic Bias Control b. User defined bias voltage



Application

- LiNbO₃ and other IQmodulators
- QPSK, QAM, OFDM, SSB and etc
- Coherent Transmission

Ordering Information

Part No.:R-BC-IQ-03

Contact: sales@rof-oc.com

¹ The highest extinction ratio depends on and cannot exceed the system modulator maximum extinction ratio.

² UART operation is only available on some version of the controller.

Performance

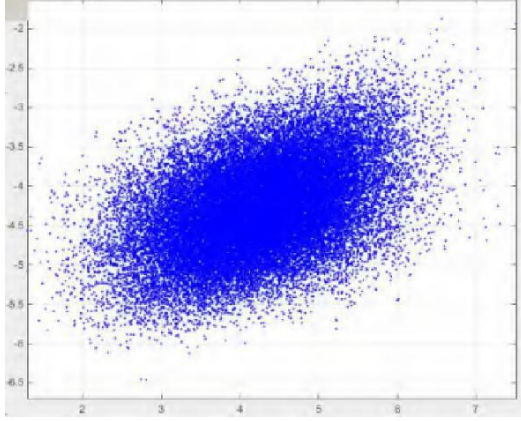

Figure 1. Constellation (without controller)

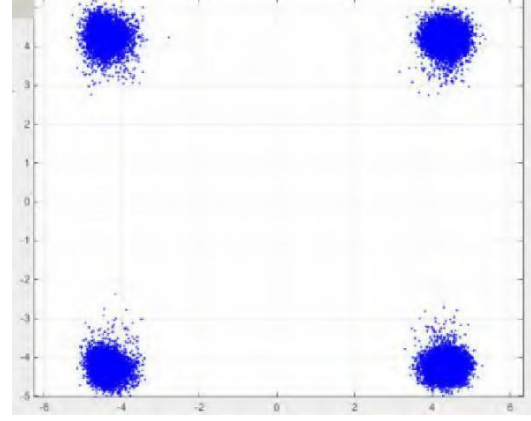

Figure 2. QPSK Constellation(with controller)

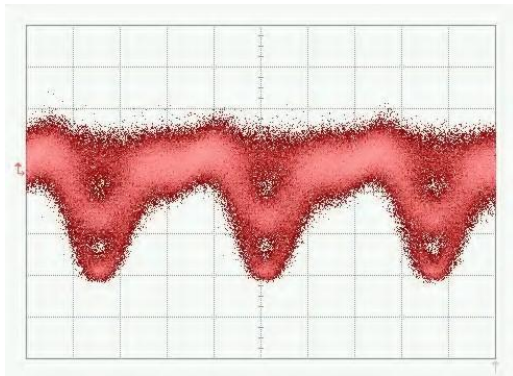

Figure 3. QPSK-Eye pattern

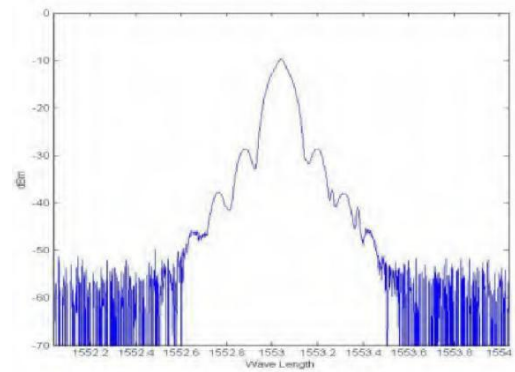

Figure 4. QPSK Spectrum

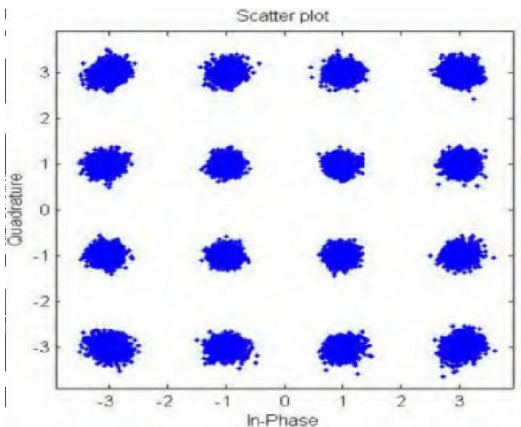

Figure 5. 16-QAM Constellation pattern

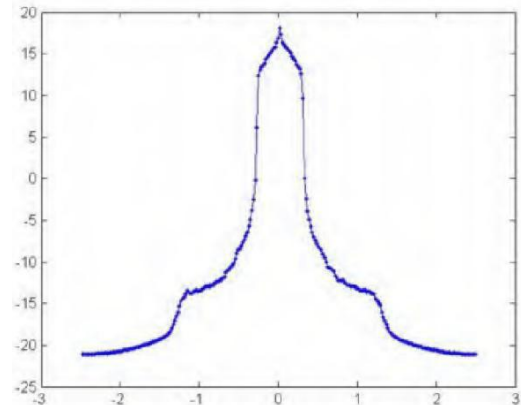

Figure 6. 16-QAM Spectrum



Specifications

Parameter	Min	Typ	Max	Unit
Controll Performance				
I, Q arms are controlled on Null(Minimum) or Peak(Maximum) point				
Extinction ratio		MER ¹	50	dB
P arm is controlled on Q+(right quadrature) or Q-(left quadrature) point				
Accuracy at Quad	-2		+2	degree ²
Stablization time	15	20	25	s
Electrical				
Positive power voltage	+14.5	+15	+15.5	V
Positive power current	20		30	mA
Negative power voltage	-15.5	-15	-14.5	V
Negative power current	8		15	mA
Output voltage range	-14.5		+14.5	V
Dither amplitude		1%V _π		V
Optical				
Input optical power ³	-30		-8	dBm
Input wavelength	1100		1650	nm

¹MER refers to intrinsic Modulator Extinction Ratio. The extinction ratio achieved is typically the extinction ratio of the modulator specified in modulator datasheet.

²Let V_π denote the bias voltage at 180° and V_P denote the most optimized bias voltage at Quad points. Then the controller bias voltage output will be in the range of $\pm V_P \pm \frac{2^\circ}{180^\circ} V_\pi$

³Please be noted that the input optical power does not refer to the optical power at the selected bias point. It is the maximum optical power that the modulator can export to the controller when the bias voltage ranges from -V_π to +V_π.

User Interface

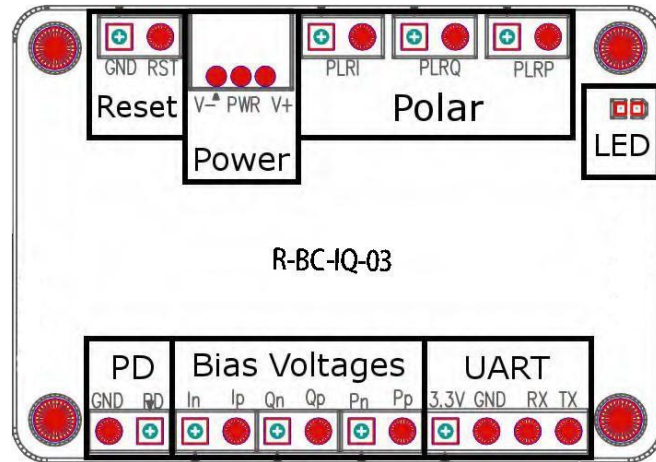

Figure 7. Assembly

Group	Operation	Explanation
Reset	Insert jumper and pull out after 1 second	Reset the controller
Power	Power source for bias controller	V- connects the negative electrode of the power supply
		V+ connects the positive electrode of the power supply
		Middle port connects with the ground electrode
Polar ¹	PLRI: Insert or pull out the jumper	no jumper: Null mode; with jumper: Peak mode
	PLRQ: Insert or pull out the jumper	no jumper: Null mode; with jumper: Peak mode
	PLRP: Insert or pull out the jumper	no jumper: Q+ mode; with jumper: Q- mode
LED	Constantly on	Working under stable state
	On-off or off-on every 0.2s	Processing data and searching for controlling point
	On-off or off-on every 1s	Input optical power is too weak
	On-off or off-on every 3s	Input optical power is too strong
PD ²	Connect with the photodiode	PD port connects the Cathode of the photodiode
		GND port connects the Anode of the photodiode
Bias Voltages	In, Ip: Bias voltage for I arm	Ip: Positive side; In: Negative side or ground
	Qn, Qp: Bias voltage for Q arm	Qp: Positive side; Qn: Negative side or ground
	Pn, Pp: Bias voltage for P arm	Pp: Positive side; Pn: Negative side or ground
UART	Operate controller via UART	3.3: 3.3V reference voltage
		GND: Ground
		RX: Receive of controller
		TX: Transmit of controller

¹ Polar depends on system RF signal. When there is no RF signal in the system, the polar should be positive. When RF signal has amplitude greater than a certain level, the polar will change from positive into negative. At this time, Null point and Peak point will switch with each other. Q+ point and Q- point will switch with each other as well. Polar switch enables user to change the polar directly without changing operation points.

² Only one choice shall be chosen between using controller photodiode or using modulator photodiode. It is recommended to use controller photodiode for Lab experiments for two reasons. Firstly, controller photodiode has ensured qualities. Secondly, it is easier to adjust the input light intensity. If using modulator's internal photodiode, please make sure that the output current of photodiode is strictly proportional to input power.